

Description

LPK is a range of compact in line duct fans. They benefit from very low profiles. The LPK 200 is only 20 mm higher than the duct diameter. This makes the LPK range an ideal choice where a low installed height is required. All fans are fitted with an external rotor motor whose bearings are sealed for life and a forward curved impeller for high performance and a very low sound level. Cleaning and maintenance are made easy with the swing out motor and impeller assembly.



Technical data

Parameter	Value	Unit
Voltage	230	V
Phase	1	~
Frequency	50	Hz
Power	0.12	kW
Current	0.55	A
R.p.m.	1750	r/m
Max. temperature of transported air	55	°C
Max. temperature of transported air when speed-controlled	55	°C
Sound pressure level at 3 m	49	dB(A)
Length	350	mm
Width	272	mm
Height	186	mm
Weight	4.4	kg
Enclosure class, motor	44	IP
Insulation class, motor	F	
Capacitor	4	µF
Duct connection	ø160 mm	

Diagrams

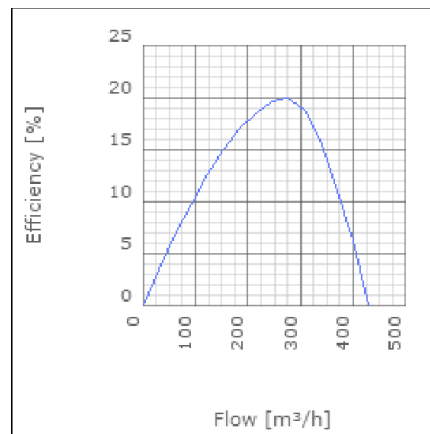
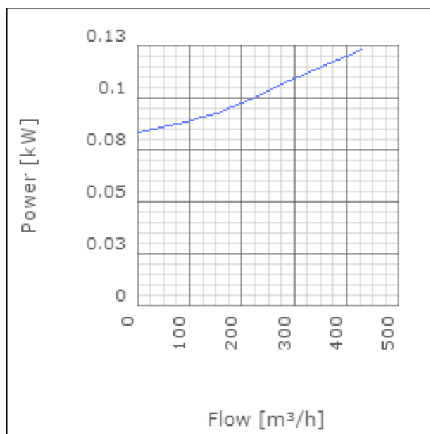
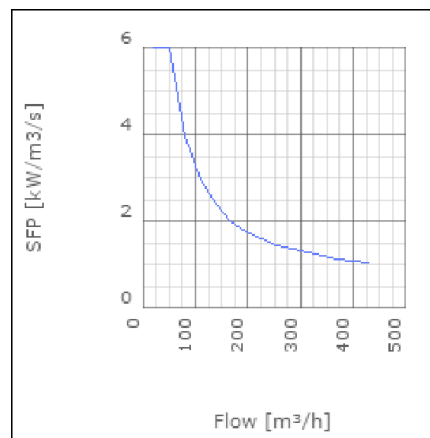
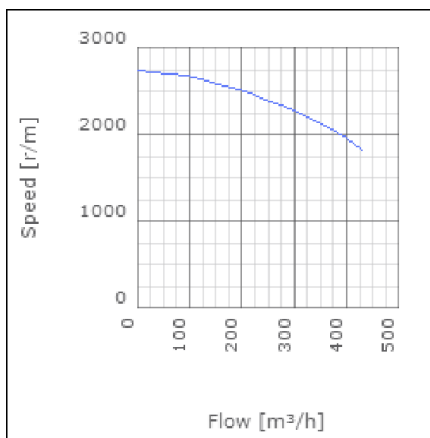
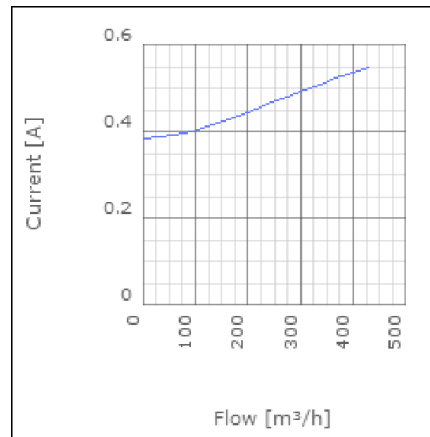
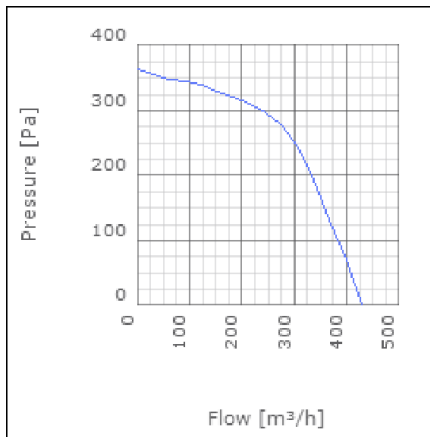

Sound

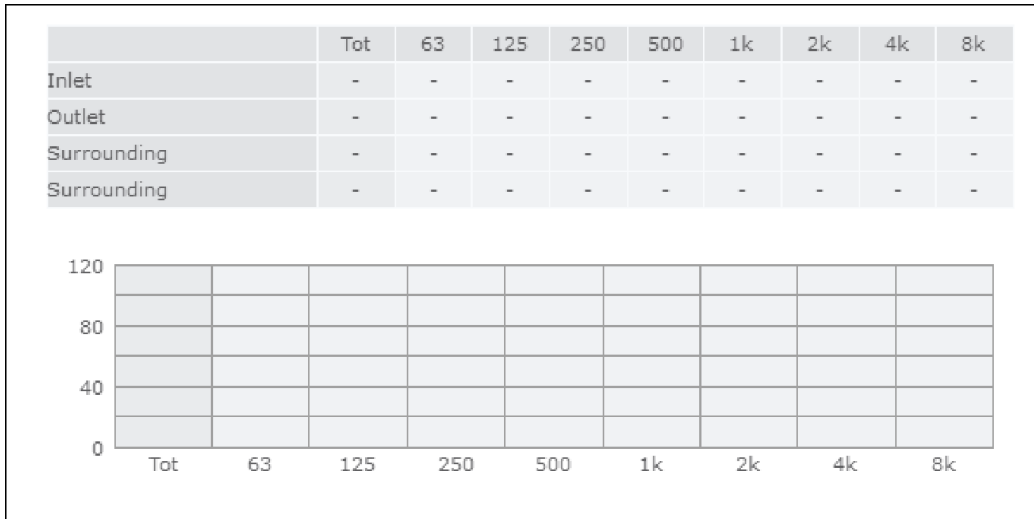
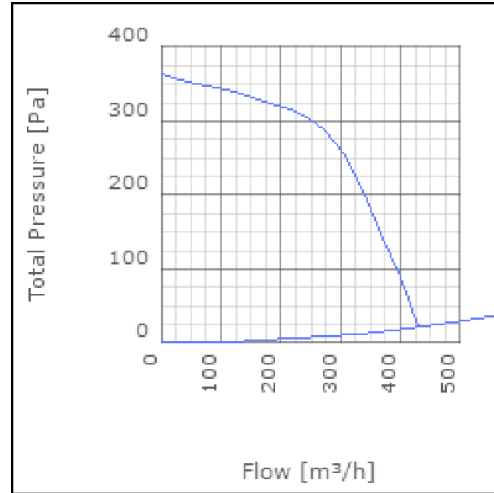
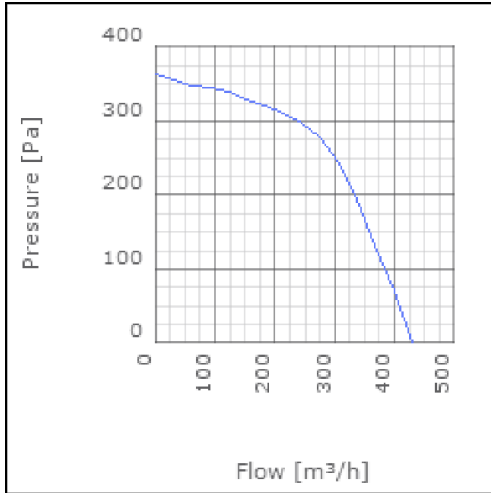

Parameter

Distance: 3.000
 Propagation type: Hemi-spherical
 Equivalent absorption area: 20.00

Dimensions

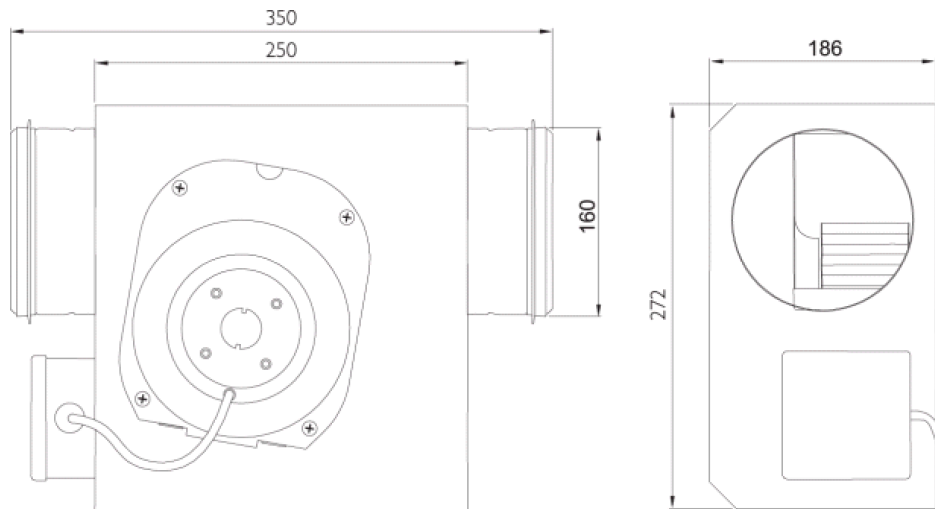

Wiring diagram

4040001

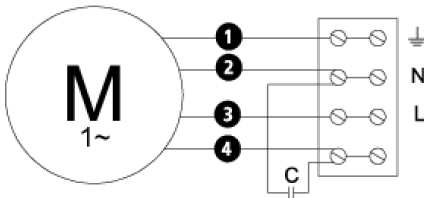

- (M) = Fan Motor
- (M1) = Fan Motor
- (M2) = Fan Motor
- (M3) = Rotor Motor
- ① = Yellow/Green
- ② = Black
- ③ = Blue
- ④ = Brown
- ⑤ = White (TW)
- ⑥ = Orange
- ⑦ = Grey
- ⑧ = Red
- ⑨ = Green
- ⑩ = Violet

Accessories

ETFV-94A
FRE 6
VRDE 1,5
VRS 1,0
VRTEC

Electrical accessories

FLF 160
FLK 160
BSV 160
YG 160
LDC 160